

KOMATSU

WA500-8

EU Stage V Engine

WHEEL LOADER

WA500



ENGINE POWER

266 kW / 357 HP @ 1.900 rpm

OPERATING WEIGHT

34.875 - 36.130 kg

BUCKET CAPACITY

4,5 - 6,3 m³

Walk-Around

WA500-8



ENGINE POWER

266 kW / 357 HP @ 1.900 rpm

OPERATING WEIGHT

34.875 - 36.130 kg

BUCKET CAPACITY

4,5 - 6,3 m³



INCREASED FUEL EFFICIENCY AND ENVIRONMENTAL PERFORMANCE

Powerful and Environmentally Friendly

- EU Stage V engine
- Komatsu SmartLoader Logic
- Large-capacity torque converter with standard lock-up
- Adjustable idle shutdown

First-Class Comfort

- New, air-suspended operator seat with integrated EPC lever console
- Large multifunctional monitor
- Low-noise design
- Rear-view camera system

Maximised Efficiency

- High efficiency buckets
- Superior dumping height and reach
- Wide tread and long wheelbase

State-of-the-Art Controls

- Automatic digging system
- Electronic Pilot Control (EPC) standard
- Intelligent gas pedal

Easy Maintenance

- Wide core radiator with auto reverse fan
- Factory fitted automatic lubrication system
- Improved gull-wing type engine doors

KOMTRAX™

- Komatsu Wireless Monitoring System
- 3G mobile communications
- Integrated communication antenna
- Increased operational data and fuel savings



A maintenance program
for Komatsu customers

Powerful and Environmentally Friendly



Komatsu SmartLoader Logic

The WA500-8 provides Komatsu SmartLoader Logic, a fully automatic engine control system. Without interfering with normal operations, this technology acquires data from various sensors in the vehicle and delivers optimal engine torque for each work phase. It limits torque during less demanding operations and reduces fuel usage without decreasing production.

Large-capacity torque converter with standard lock-up

With its large-capacity torque converter, the completely redesigned Komatsu drive train offers optimum efficiency and an unparalleled rimpull-to-weight ratio. By delivering high rimpull at low speeds, it makes child's play of heavy jobs like penetration of dense material such as aggregate. This means higher productivity in V-Shape loading, even in confined spaces.

More fuel-saving technology

The selectable engine mode and adjustable idle shutdown are tools to considerably lower fuel usage. The WA500-8's Eco-gauge displays active recommendations on the cab's monitor to help you maximise those fuel savings. For more fuel economy, the electronically controlled hydraulics pumps for the work and steering system prevent wasted hydraulic flow and deliver the exact amount of oil required for all movements of the machine.

WA500-8

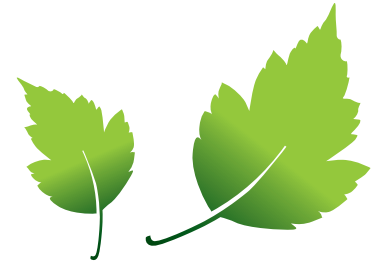

Komatsu EU Stage V

The Komatsu EU Stage V engine is productive, dependable and efficient. With ultra-low emissions, it provides a lower environmental impact and a superior performance to help reduce operating costs and lets the operator work in complete peace of mind.

Heavy-duty aftertreatment

The aftertreatment system combines a Komatsu Diesel Particulate Filter (KDPF) and Selective Catalytic Reduction (SCR). The SCR injects the correct amount of AdBlue® into the system at the proper rate to break down NOx into water (H₂O) and non-toxic nitrogen gas (N₂). NOx emissions are reduced by 80% vs. EU Stage IIIB engines.

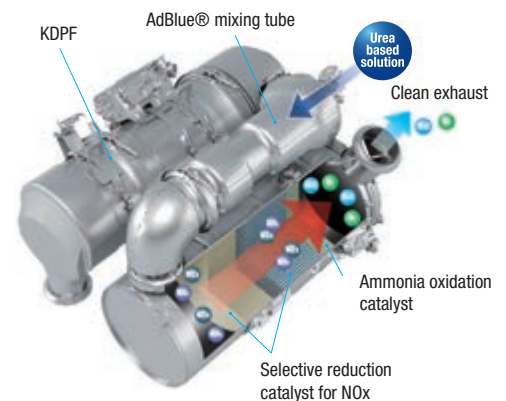

Fuel consumption history

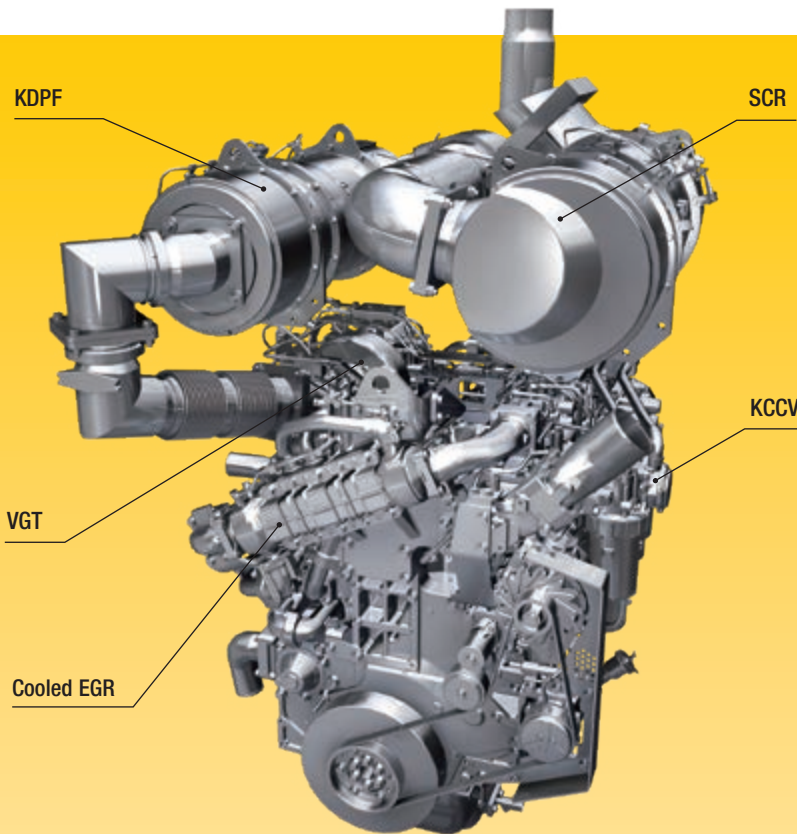

Exhaust Gas Recirculation (EGR)

Cooled EGR is a technology well-proven in current Komatsu engines. The increased capacity of the EGR cooler now ensures very low NOx emissions and a better engine performance.

High-Pressure Common Rail (HPCR)

To achieve complete fuel burn and lower exhaust emissions, the heavy-duty High-Pressure Common Rail fuel injection system is computer controlled to deliver a precise quantity of pressurised fuel into the redesigned engine combustion chamber by multiple injections.

Komatsu Closed Crankcase Ventilation (KCCV)

Crankcase emissions (blow-by gas) are passed through a CCV filter. The oil mist trapped in the filter is returned back to the crankcase while the filtered gas is returned to the air intake.

Variable Geometry Turbo (VGT)

The VGT provides optimal airflow to the engine combustion chamber under all speed and load conditions. Exhaust gas is cleaner, fuel economy is improved while machine power and performance are maintained.



Eco-gauge and an Eco guidance with active recommendations help maximising fuel savings



Adjustable idle shutdown automatically turns off the engine after it idles for a set period of time

Maximised Efficiency

Faster Load & Carry

The sequential torque converter lock-up system delivers unbeatable productivity and fuel efficiency in Load & Carry and short distance transport applications. The operator can engage the system from 2nd to 4th gear. It noticeably increases travel speed, particularly when going uphill, thanks to the larger tractive force. It also significantly reduces fuel consumption by eliminating converter losses.

Superior dumping height and reach

The long lifting frame allows an enormous dumping height of 3.385 mm and a reach of 1.380 mm that is just as impressive (with a 5,6 m³ bucket, measured to the cutting edge). With this working range, loading high feeders or trucks becomes easy and fast.

New high efficiency buckets

Soil slips easily from the redesigned bucket, and digging work is more efficient. Operations are easier and productivity improved, especially in combination with the new auto digging system.

Precision control

Komatsu's CLSS hydraulics enables extremely precise control of the work equipment, and ensures that the bucket, boom and hydraulically driven attachments can all move smoothly at the same time. The WA500-8 also features variable-displacement pumps on both the hydraulic and steering systems. These pumps deliver the exact amount of oil required, dramatically improving fuel efficiency.



WA500-8



First-Class Comfort

Increased comfort

In the wide Komatsu SpaceCab™, a standard air-suspended high-back seat, heated for improved comfort and with fully adjustable armrests, is the centre of a comfortable and low-fatigue working environment. High visibility and ergonomic controls further assist to maximise the operator's productivity.

Perfect operator convenience

In addition to the standard radio, the WA500-8 has an auxiliary input for connecting external devices and play music through the cab speakers. Two 12-volt power ports are also incorporated in the cab. Proportional controls are fitted as standard for safe and precise operation of attachments. The cab features large trays and storage boxes for tools and manuals and a hot and cool box.

New automatic digging system

The new automatic digging system actuates the bucket tilt and lifting operations by detecting the sensing pressure applied to the work equipment. The system adapts to different types of material with no human intervention required. Operator fatigue is greatly reduced and ideal load capacity ensured.



WA500-8

State-of-the-Art Controls

New, fully air suspended operator station

The wide spacious cab features a new, fully air suspended operator seat that includes the side consoles mounted together with a high back, fully adjustable, standard heated seat for improved comfort. A seat ventilation is optionally available to maximise comfort.

Easy-to-use joystick steering (option)

A joystick steering system is available as optional equipment, and ensures that steering can be wrist operated easily and conveniently in loading operations. This system allows you to change the direction of travel and gear shifting with push buttons on the joystick. And you may pre-select the steering speed in 2 stages, depending upon whether fast V-loading or precise load & carry is required.

Intelligent gas pedal

To reduce fuel usage, Komatsu's innovative thrust-sensing gas pedal automatically helps you match the timing of gear shifts to the load. In heavy-duty work, requiring high rimpull and maximum acceleration, we tend to press heavily on the gas pedal. The WA500-8 anticipates this and shifts up gears as late as possible. In light-duty work, where fuel consumption is a major factor, the operator will intuitively press the gas pedal lightly. Again, the machine anticipates this – and shifts up gears as early as possible to achieve highest fuel efficiency.

“By Wire” operating

The Electronic Pilot Control (EPC) lever console is integrated with the seat and can be easily adjusted to suit any operator. The short levers are fingertip controlled for precise and fatigue-free operating, with a no-vibration modulating function for slowing and stopping a lowering bucket. The upper and lower boom cut-out position can be pre-set with a switch.

Rear view camera

A standard fitment camera gives an exceptionally clear view of the rear work zone on the wide-screen colour monitor panel. The low profile camera is adjustable and integrated into the engine hood's shape.

EPC-multi-function lever (option)

The EPC-multi-function lever with an integrated forward/reverse switch allows the simplest and most comfortable operation of the equipment. With one hand the driver can simultaneously control the attachment and switch between forward and reverse. The multi-function lever is the perfect choice for earth moving jobs.

Auto-kickdown

The WA500-8 can automatically shift down from F2 to F1 to make operations easier and more productive.



Auxiliary input (MP3 jack)



Hot and cool box



EPC-Multifunction lever (option)

Information & Communication Technology



Lower operating costs

Komatsu ICT contributes to the reduction of operating costs by assisting to comfortably and efficiently manage operations. It raises the level of customer satisfaction and the competitive edge of our products.

Large TFT colour monitor

A large user-friendly colour monitor enables safe, accurate and smooth work. Multilingual and with all essential information available at a glance, it features simple and easy-to-operate switches and multifunction keys that provide fingertip access to a wide range of functions and operating information.

Eco guidance

The monitor panel displays instant guidance messages to help promote energy saving, and the Eco-gauge indicates the actual fuel consumption: keep the Eco-gauge in the green zone for better fuel efficiency. To further improve savings, logs can be consulted for operations, Eco guidance and fuel consumption. The information is available in KOMTRAX™ and can be used for operator trainings and jobsite optimisation.



Information at a glance: basic dashboard LCD monitor



A multifunction monitor displays and controls a wealth of operational and maintenance information

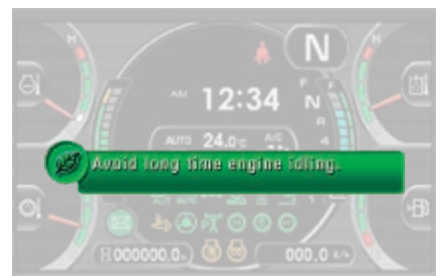

Eco guidance supports energy saving in real time (e.g. avoid long time engine idling)

WA500-8

KOMTRAX™

The way to higher productivity

KOMTRAX™ uses the latest wireless monitoring technology. Compatible on PC, smartphone or tablet, it delivers insightful and cost saving information about your fleet and equipment, and offers a wealth of information to facilitate peak machine performance. By creating a tightly integrated web of support it allows proactive and preventive maintenance and helps to efficiently run a business.



Knowledge

You get quick answers to basic and critical questions about your machines – what they're doing, when they did it, where they're located, how they can be used more efficiently and when they need to be serviced. Performance data is relayed by wireless communication technology (satellite, GPRS or 3G depending on model) from the machine to a computer and to the local Komatsu distributor – who's readily available for expert analysis and feedback.

Power

The detailed information that KOMTRAX™ puts at your fingertips 24 hours a day, 7 days a week gives the power to make better daily and long-term strategic decisions – at no extra cost. Problems can be anticipated, maintenance schedules customised, downtime minimised and machines kept where they belong: working on the jobsite.

Convenience

KOMTRAX™ enables convenient fleet management on the web, wherever you are. Data is analysed and packaged specifically for effortless and intuitive viewing in maps, lists, graphs and charts. You can foresee eventual maintenance issues and required spare parts, and troubleshoot a problem before Komatsu technicians arrive on site.



Easy Maintenance



Easy access to service points

For easy and safe opening the gull-wing doors are supported by gas springs. The large doors give a convenient access from ground level to all daily service points. With long service intervals and filters collected in a centralised arrangement, machine downtime is reduced to a minimum.



Wide core radiator with auto reverse fan

A wide core radiator prevents clogging even when working in a dusty environment. To minimize manual cleaning, a reversible fan blows dust out, automatically or on demand. The “automatic reverse” function allows to set the cleaning length and the time between cleaning to adjust perfectly to the working conditions.



AdBlue® tank

The AdBlue® tank is located on the right hand side of the machine behind a ladder for easy access.

Diesel particulate filter regeneration

No interruption or extension of daily work is required to regenerate the diesel particle filter system. Due to its superior Komatsu technology, KDPF regeneration takes place automatically, at any time.

Komatsu CARE™

Komatsu CARE™ is a maintenance program that comes as standard with your new Komatsu machine. It covers factory-scheduled maintenance, performed with Komatsu Genuine parts by Komatsu-trained technicians. Depending on your machine's engine, it also offers extended coverage of the Komatsu Diesel Particulate Filter (KDPF) or the Komatsu Diesel Oxidation Catalyst (KDOC), and of the Selective Catalytic Reduction (SCR). Please contact your local Komatsu distributor for terms and conditions.



Equipment Management and Monitoring System (EMMS)

The large high resolution monitor panel displays various machine information and allows for multiple settings. The “Operation Records” menu shows records of the average fuel consumption, idling hours, and other features. Abnormality codes are clearly displayed and stored to alert you and simplify troubleshooting. The monitor also provides for advanced monitoring of the system parameters through the Service Mode to aid in troubleshooting and reduce downtime.



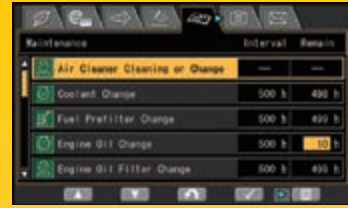

Basic maintenance screen



Aftertreatment device regeneration screen for the KDPF



AdBlue® level gauge and refill guidance



Quality You Can Rely On

Designed and built by Komatsu

The engine, hydraulics, power train, front and rear axles are original Komatsu components. All these components are subject to the highest quality standards right down to the smallest screw. All components are fully co-ordinated with one another, thus offering the maximum efficiency and reliability.

Heavy-duty axles

The heavy-duty axles allow exceptional service life even under the toughest working conditions. The optional limited slip differentials are most suitable for soft and slippery ground like sand or wet soil.

Robust torsion-resistant main frame

The frame design with hinge points far apart guarantees the high stability for the overall construction and reduces bearing stress in the torsional ranges.

Wet multi-disc service brake

The multi-disc service brake is encapsulated and runs in an oil bath. The brake stays clean and operates at low temperature for increased service intervals and a long lifetime.



Robust torsion-resistant main frame

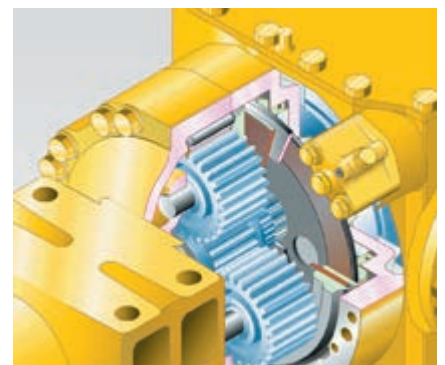

Wet multi-disc service brake

WA500-8



Buckets and Attachments



Universal bucket

This type of bucket is impressive because of its excellent penetration and loosening properties and its good material holding properties. This universal bucket can be equipped with flush mount adapters and interchangeable teeth.



Rock bucket

V-shaped buckets offer excellent penetration properties for medium heavy-duty rock jobs. Robust hardox design wear plates ensure a long service life. Komatsu offers a selection of optional equipment with the high wear-resistant Kmax™ cutting tools for extremely abrasive jobs.

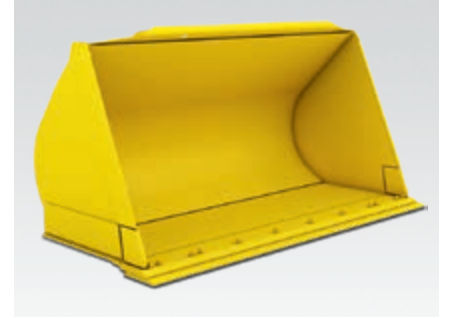

Stock pile bucket with raised bottom

The stock pile bucket with raised bottom is the right solution for handling loose and relatively light materials on paved grounds. The combination of rounded shovel back and the straight sidewalls contributes to good filling properties and less material spillage.



Kmax™ tooth system

The Kmax™ tooth system optimizes the bucket performance and makes changing teeth quick and easy. It comes with a patented locking system in which teeth are held in place with lateral pins. Kmax™ uses the highest-specification steels with a number of tooth styles to suit a variety of applications.



Hydraulic quick coupler

The WA500-8 can change attachments in a matter of seconds with a market compatible or HD wedge type quick coupler. With the wedge type quick coupler, featuring a unique and innovative design, the offset to the original connection points is reduced to a minimum. Thus, lifting forces remain almost the same compared to a direct mounted bucket.



A comprehensive range of attachments

The log grapple: With its sturdy structure and its great hydraulic power and a special tilting cylinder, the WA500-8 is also perfectly suited to work in the timber industry. The robust design of the lifting frame and axles ensures maximum durability.

Specifications

ENGINE

Model	Komatsu SAA6D140E-7
Type	Common rail direct injection, water-cooled, emissionised, turbocharged, after-cooled diesel
Engine power	
at rated engine speed	1.900 rpm
ISO 14396	266 kW/357 HP
ISO 9249 (net engine power)	264 kW/353 HP
Max. torque / engine speed	1.785 Nm / 1.250 rpm
No. of cylinders	6
Bore x stroke	140 x 165 mm
Displacement	15,24 l
Fan drive type	Hydraulic
Alternator	90 A/24 V
Starter motor	11 kW/24 V
Filter	Main-flow filter with water separator
Air-filter type	Dry-air filter with automatic dust emission and preliminary purification including a dust display
Fuel	Diesel fuel, conforming to EN590 Class 2/ Grade D. Paraffinic fuel capability (HVO, GTL, BTL), conforming to EN 15940:2016

TRANSMISSION

Type	Automatic powershift transmission
Torque converter	One-stage, two-phase, 3-element, with lock-up clutch

SPEEDS IN KM/H (WITH 29.5 R25 TYRES)

Gear	1.	2.	3.	4.
Forward	7,5	12,9	22,2	35,5
with torque converter lock-up	–	13,1	23,7	37,3
Reverse	8,5	12,9	24,7	38,0
with torque converter lock-up	–	13,0	26,6	38,0

CHASSIS AND TYRES

System	4-wheel drive
Front axle	Komatsu HD axle, full-floating (LSD-differential optional)
Rear axle	Komatsu HD axle, full-floating, 20° swing angle (LSD-differential optional)
Differential	Spiral bevel gear pair
Final drive	Planetary gear in an oil bath
Tyres	29.5 R25

SERVICE REFILL CAPACITIES

Fuel tank	473 l
Engine oil	37 l
Hydraulic system	337 l
Cooling system	110 l
Front axle	95 l
Rear axle	95 l
Torque converter and transmission	71 l
AdBlue® tank	36 l

BRAKES

Operating brakes	Hydraulically actuated, wet multi-disc brakes on all wheels
Parking brake	Wet multi-disc
Emergency brake	Uses the parking brake

HYDRAULIC SYSTEM

Type	Komatsu CLSS (Closed Centre Load Sensing System)
Hydraulic pump	Variable piston pump
Working pressure	350 kg/cm ²
Maximum pump flow	320 l/min
No. of hydraulic/bucket cylinders	2/1
Type	Double-action
Bore diameter x stroke	
Boom cylinder	160 x 898 mm
Bucket cylinder	185 x 675 mm
Hydraulic cycle with rated load bucket filling	
Raise time	7,2 s
Lowering time (empty)	4,2 s
Dumping time	1,7 s

STEERING SYSTEM

System	Articulated frame steering
Type	Completely hydraulic power steering
Steering angle to either side	40°
Steering pump	Variable piston pump
Working pressure	250 kg/cm ²
Pumping capacity	120 l/min
No. of steering cylinders	2
Type	Double-action
Bore diameter x stroke	100 x 486 mm
Smallest turn (outer edge of the tyre 29.5 R25)	7.050 mm

CABIN

Two-door SpaceCab™ in conformity with ISO 3471 with ROPS (roll over protective structure) in conformity with SAE J1040c and FOPS (falling object protective structure) in conformity with ISO 3449. The air-conditioned pressurised cabin is mounted upon hydrobearings and is noise dampened.

ENVIRONMENT

Engine emissions	Fully complies with EU Stage V exhaust emission regulations
Noise levels	
LwA external	109 dB(A) (2000/14/EC Stage II)
LpA operator ear	72 dB(A) (ISO 6396 dynamic test)
Vibration levels (EN 12096:1997)	
Hand/arm	≤ 2,5 m/s ² (uncertainty K = 1,12 m/s ²)
Body	≤ 0,5 m/s ² (uncertainty K = 0,24 m/s ²)
Contains fluorinated greenhouse gas HFC-134a (GWP 1430). Quantity of gas 1,1 kg, CO ₂ equivalent 1,57 t.	

Dimensions & Performance Figures

MEASUREMENTS AND WORKING SPECIFICATIONS

Bucket type		Universal bucket with straight edge		Rock bucket with straight edge	
		with teeth	with BOC	with teeth	with BOC
Bucket capacity (heaped, ISO 7546)	m ³	5,3	5,6	5,6	5,6
Sales code	3809	C02	C03	C42	C43
Material density	t/m ³	2,00	1,90	1,85	1,85
Bucket weight (without teeth)	kg	2.860	2.905	3.665	3.405
Static tipping load, straight	kg	26.775	26.510	25.550	25.895
Static tipping load, 40° articulated	kg	24.210	23.965	23.015	23.360
Break-out force hydraulic	kN	276	262	261	262
Lifting capability hydr. at ground level	kN	289	287	278	282
Operating weight	kg	35.110	35.155	35.920	35.660
Turning radius at corner of tyres	mm	7.050	7.050	7.050	7.050
Turning radius at bucket edge	mm	8.235	8.180	8.275	8.195
a Reach at 45°	mm	1.560	1.380	1.535	1.370
b Dumping height at 45°	mm	3.235	3.385	3.175	3.380
c Hinge pin height	mm	4.770	4.770	4.770	4.770
d Height top edge of bucket	mm	6.515	6.515	6.750	6.750
e Digging depth	mm	125	150	190	160
f Max. loading height	mm	4.425	4.425	4.410	4.410
A Overall length	mm	9.990	9.780	10.070	9.789
B Wheel base	mm	3.780	3.780	3.780	3.780
C Bucket width	mm	3.430	3.430	3.460	3.460
D Width over tyres	mm	3.150	3.150	3.150	3.150
E Track width	mm	2.400	2.400	2.400	2.400
F Ground clearance	mm	465	465	465	465
H Overall height	mm	3.800	3.800	3.800	3.800

All measurements with tyres 29.5 R25 (XHA2) and additional rear counterweight (A15).
 Details of dumping heights and reach to cutting edge or bolt-on cutting edge (BOC) or teeth.

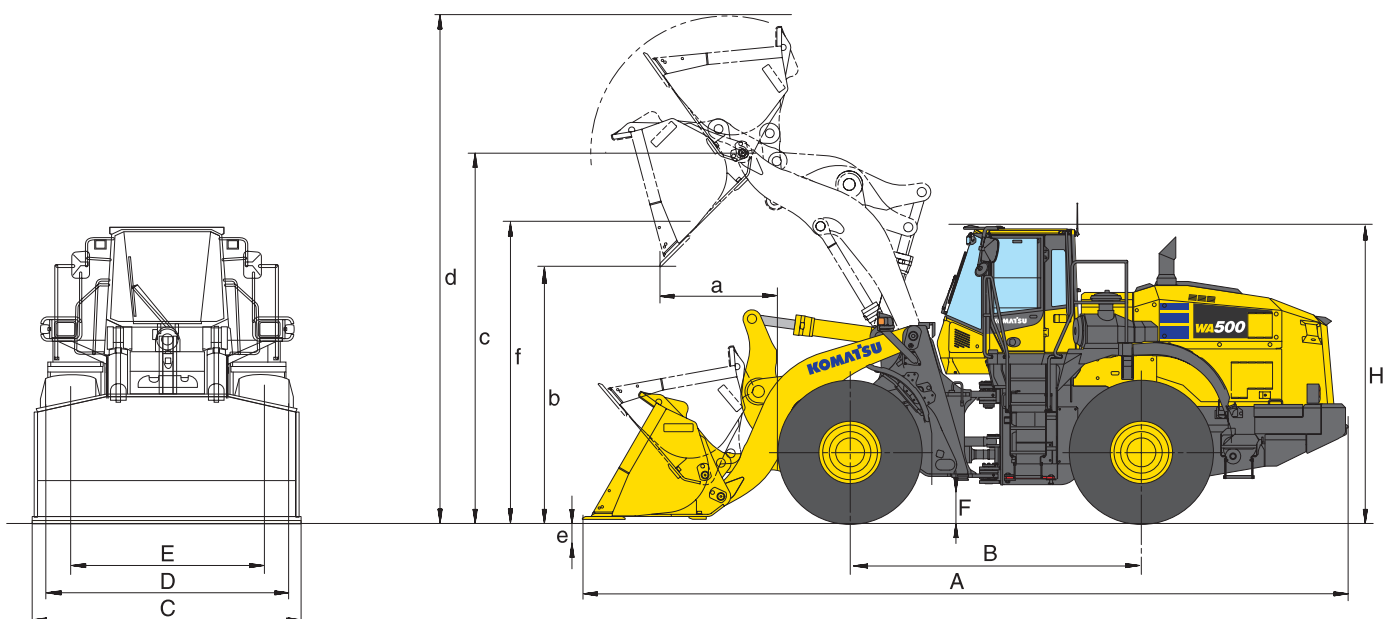

WA500-8

Rock bucket with spade nose		Stock pile bucket with straight edge		without additional counterweight (A15)	with tyres 29.5 R25 XMINE (D2)	with High Lift (with additional counterweight A15)
with teeth and teeth segments	with BOC	with teeth	with BOC			
5,6	5,6	6,0	6,3			
C46	C47	C06	C07			
1,80	1,85	1,80	1,70	- 0,15	+ 0,05	- 0,35
3.875	3.615	3.064	3.110			
25.015	25.420	26.295	26.010	- 1.895	+ 755	- 4.395
22.505	22.905	23.755	23.490	- 1.595	+ 755	- 4.070
227	225	254	242			- 3,45
273	277	283	281			- 53
36.130	35.870	35.315	35.365	- 900	+ 1.080	+ 360
7.050	7.050	7.050	7.050			
8.275	8.265	8.270	8.215			+ 205
1.700	1.545	1.650	1.465		- 20	+120
3.010	3.205	3.150	3.300		+25	+410
4.770	4.770	4.770	4.770		+25	+410
6.750	6.750	6.665	6.665		+25	+410
190	160	125	150		-25	-75
4.410	4.410	4.425	4.425		+25	+410
10.300	10.035	10.115	9.905		-20	+485
3.780	3.780	3.780	3.780		0	
3.460	3.460	3.430	3.430		0	
3.150	3.150	3.150	3.150		+55	
2.400	2.400	2.400	2.400		0	
465	465	465	465		+25	
3.800	3.800	3.800	3.800		+25	

Basalt	1.960	Gravel, unscreened	1.930	Sandstone	1.510
Bauxite, Kaolin	1.420	Gravel, dry	1.510	Slate	1.250
Earth, dry, ex store	1.510	Gravel, dry, 6-50 mm	1.690	Slag, broken	1.750
Earth, wet, excavated.....	1.600	Gravel, wet, 6-50 mm.....	2.020	Stone, crushed	1.600
Gypsum, broken.....	1.810	Sand, dry, loose	1.420	Clay, natural	1.660
Gypsum, crushed.....	1.600	Sand, damp.....	1.690	Clay, dry	1.480
Granite, broken.....	1.660	Sand, wet	1.840	Clay, wet.....	1.660
Limestone, broken.....	1.540	Sand and clay, loose.....	1.600	Clay and gravel, dry.....	1.420
Limestone, crushed.....	1.540	Sand and gravel, dry	1.720	Clay and gravel, wet.....	1.540

BUCKET SELECTION GUIDE



 115 100 95%

 Bucket fill factor

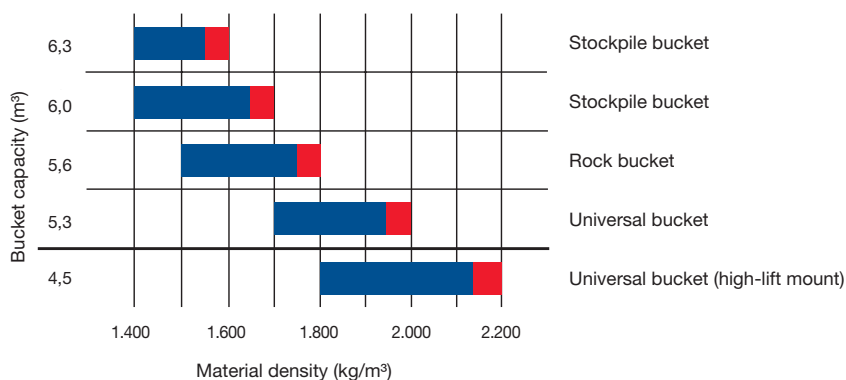

Standard and Optional Equipment

ENGINE

Komatsu SAA6D140E-7 turbocharged common rail direct injection diesel engine	●
EU Stage V compliant	●
Engine mode selection system: Power, Economy	●
Komatsu SmartLoader Logic	●
Adjustable idle shutdown	●
Auto-deceleration function	●
Fuel filter with water separator	●
Batteries 2 × 180 Ah/2 × 12 V	●

CHASSIS AND TYRES

Heavy-duty axles	●
Front fenders	●
Full rear fenders	●
Limited-slip differential (LSD) front and rear	○
Tyres 29.5 R25 L2, L3, L5	○
Brake cooling system (front & rear)	○

HYDRAULIC SYSTEM

2-spool main control valve	●
EPC fingertip control, two levers, including:	
- Bucket stop modulation	●
- Boom stop pre-setting	●
- Automatic dig function	●
Automatic return-to-dig	●
3-spool main control valve	○
EPC fingertip control, three levers	○
EPC 1-lever (Multi-function lever) with sliding proportional control for attachments	○
Biodegradable oil for hydraulic system	○

TRANSMISSION AND BRAKES

Electronically controlled ECMV automatic transmission with mode selector and variable transmission cut-off	●
Transmission shift mode selection system	●
Large-capacity torque converter	●
Torque converter lock-up	●
Auto-kickdown	●

CABIN

Spacious double door driver's cab to DIN/ISO	●
ROPS/FOPS frame according to SAE	●
Heated, high back air suspension seat, console mounted height adjustable arm rests	●
Retractable seat belt	●
Automatic climate control system	●
Multi-function video compatible colour monitor with Equipment Management and Monitoring System (EMMS) and efficiency guidance	●
DAB+ digital radio w. auxiliary input (MP3 jack)	●
Hot and cool box	●
Heated rear window	●
Rear window wiper	●
Adjustable steering column	●
2 × 12 V power supply	●
Heated, high back air suspension seats with pneumatically adjustable lumbar support, console mounted height adjustable arm rests	○
Joystick steering with integrated F/R transmission function, 2-stage	○
3-point seat belt	○
Sun roller blind	○

LIGHTING SYSTEM

2 halogen main headlights	●
2 spotlights at front and rear	●
Reversing light	●
Additional lights front and rear	○
LED working lights	○
Xenon working lights	○
Step light	○

SERVICE AND MAINTENANCE

Hydrostat-driven radiator fan with automatic reversing function	●
Wide core radiator	●
KOMTRAX™ – Komatsu wireless monitoring system (3G)	●
Komatsu CARE™ – a maintenance program for Komatsu customers	●
Tool-set	●
Automatic central lubrication	●
Filling tool for central lubrication system	○
Turbo II air pre-cleaner, cyclone type	○

SAFETY EQUIPMENT

Emergency steering system	●
Vandalism protection	●
Back-up alarm	●
Battery main switch	●
Handrails on left/right	●
Rear-view camera system	●
Front screen protective grid	○
Fire extinguisher	○
Beacon light	○
Roof rail	○
Rear view mirror, heated and remote control	○
Optical back-up alarm (strobe light)	○

ATTACHMENTS

High-lift equipment	○
Hydraulic quick-coupler	○
Universal buckets	○
Rock buckets	○
Stock pile buckets	○
Fork carrier and tines	○

OTHER EQUIPMENT

Counterweight	●
Electronically controlled load stabilizer (ECSS II)	●
Special custom colour	○
Cold area kit (engine and cab pre-heating)	○

Further equipment on request

- standard equipment
- optional equipment

Your Komatsu partner:

KOMATSU

**Komatsu Europe
International N.V.**

Mechelsesteenweg 586
B-1800 VILVOORDE (BELGIUM)
Tel. +32-2-255 24 11
Fax +32-2-252 19 81
www.komatsu.eu

VENSS05903 02/2020

KOMATSU is a trademark of Komatsu Ltd. Japan.